

JB SANITARY

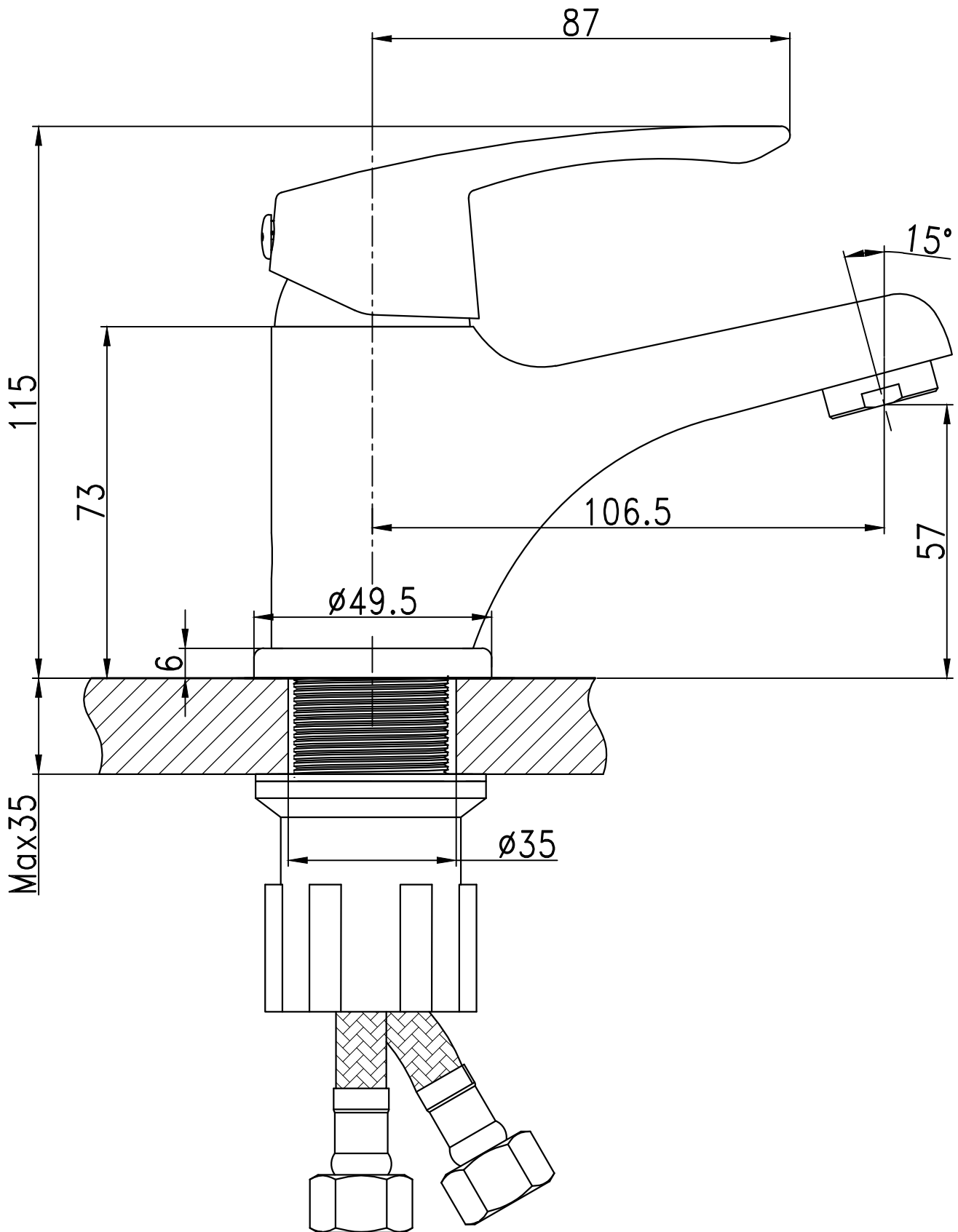

L10 05 00